

HOPPER GUARD



Open lid and install safety guard.

ANTENNA



Screw antenna onto control board.

✓ YOUR GRILL IS READY!

PLEASE READ THE SAFETY INFORMATION AND OPERATING INSTRUCTIONS IN YOUR MANUAL BEFORE INITIAL START UP



HAVE QUESTIONS?

The new grill owners guide is your one-stop-shop for everything from initial fire-up to general operating tips and troubleshooting. For support questions feel free to check out our support page.



NEW GRILL OWNERS
greenmountaingrills.com/new-grill-owners/



GMG SUPPORT
greenmountaingrills.com/support/



PEAK

PRIME

ASSEMBLY GUIDE



EASY STEP-BY-STEP VIDEO ASSEMBLY

SCAN THE QR CODE WITH YOUR PHONE OR GO TO:
GREENMOUNTAINGRILLS.COM/GRILL-ASSEMBLY



PLEASE READ AND FOLLOW ALL ASSEMBLY INSTRUCTIONS, SAFETY INFORMATION, AND OPERATING INSTRUCTIONS OF YOUR OWNER'S MANUAL BEFORE INITIAL START UP.



GRILL PARTS LIST



PART	DESCRIPTION	PART	DESCRIPTION
1	Grill Lid Handle	9	Grill Grates
2	Chimney	10	Grease Tray
3	Internal Grill Light	11	Heat Shield
4	Collapsible Front Shelf	12	Heat Shield Adjustment Handle
5	Front Shelf Mount Brackets	13	Grease Bucket
6	Locking Caster Wheel Legs	14	Side Shelf
7	Oversized Green Wheel Legs	15	Hopper Safety Guard
8	Bottom Storage Shelf	16	Food Probes



POWER COMPONENTS



HARDWARE



ASSEMBLY

PLEASE READ AND FOLLOW ALL INSTRUCTIONS CAREFULLY

UNBOXING & LEG INSTALLATION

HARDWARE

IMPORTANT! The grill is very heavy. Always use 2 people when lifting the grill.



1 UNBOXING



Open and remove front shelf.

2 UNBOXING



Open **STARTER BOX**. Reference parts list. Remove cardboard filling.

3 UNBOXING

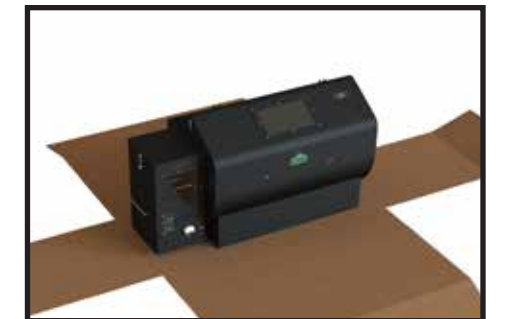

Cut down box corners to access grill. Remove internal parts & legs.

4 LAY BACK FOR LEG ACCESS

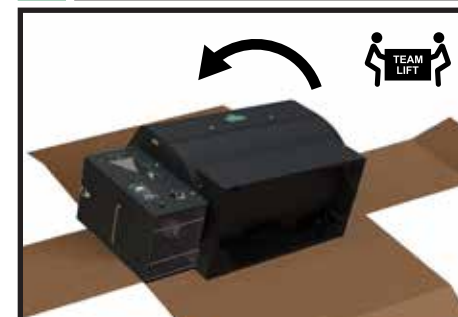

Lay grill down on its back. Keep on cardboard to prevent scratches.

5 INSTALL LEGS



Use extra cardboard to prop up grill base for easier leg installation.

6 INSTALL LEGS

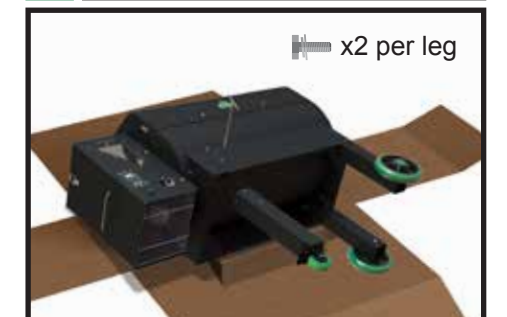

Install legs correctly as shown here. x2 per leg

BOTTOM SHELF

IMPORTANT! The grill is very heavy. Always use 2 people when lifting the grill.

7 STAND GRILL UPRIGHT



Carefully lift grill up and stand upright.

8 INSTALL BOTTOM SHELF



Slide shelf down to sit on shelf arm bolts. Align with grooves under shelf.

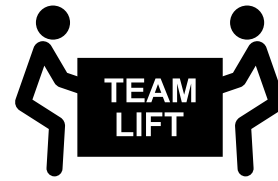

LID HANDLE

IMPORTANT! Keep 2 spacers on each side of the grill lid to minimize heat transfer to the handle.

HARDWARE

12mm

9 REMOVE HANDLE



Unscrew handle from inside grill lid.

10 INSTALL HANDLE



Flip hand around to the front and fasten to lid as shown here.

FRONT & SIDE SHELVE

NOTE: Front shelf mount brackets attach in the same holes used for the front legs.

HARDWARE

10mm

11 MOUNT BRACKETS



Install brackets in leg holes.
x4

12 FRONT SHELF



Attach front shelf hinges to brackets.
x4

13 SIDE SHELF

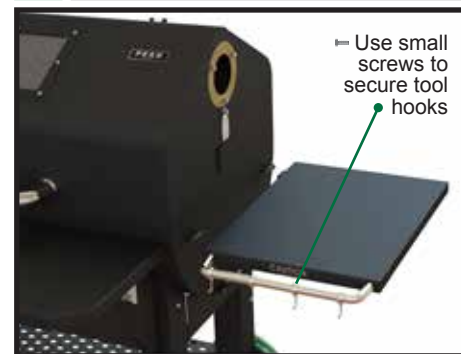

Line up the bullets with the pins on side wall and clip shelf into support bar.

CHIMNEY

IMPORTANT! Make sure the chimney cap ALWAYS stays open.

HARDWARE

10mm

14 REMOVE BOLTS

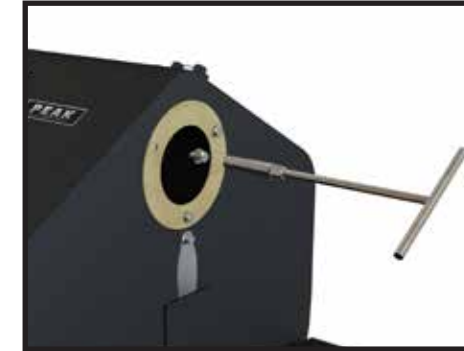

15 INSTALL CHIMNEY



HEAT SHIELD

IMPORTANT! For proper heat shield positioning, use the marks on the adjuster handle. The grill wall should align with the -.5 mark on the handle, setting the heat shield 9.25 in. from the left inside grill wall.

HEAT SHIELD ADJUSTER

SWEET SPOT

16 HEAT SHIELD



Insert heat shield onto stainless steel slider mount brackets.

17 HEAT SHIELD ADJUSTER

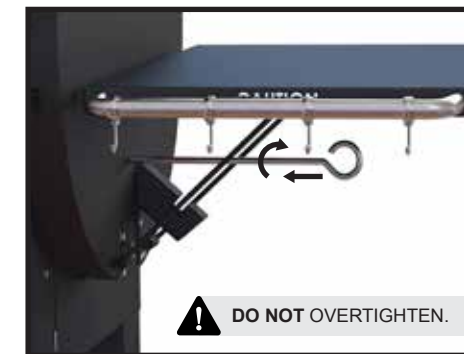

Insert adjuster handle into hole on right side of grill wall and screw into head shield.

18 HEAT SHIELD POSITIONING

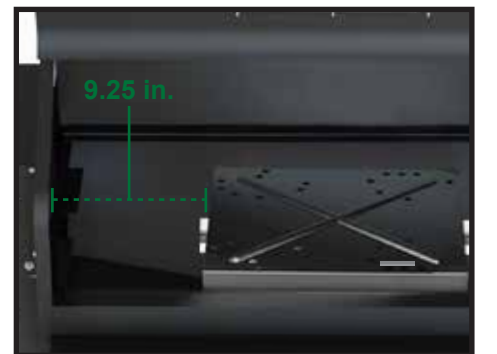

Recommended position for even heat distribution:
approx. 9.25 in. from left wall.

GREASE TRAY, GRATES, & GREASE BUCKET

IMPORTANT! Make sure to insert grease tray as shown below for proper temperature reading and grease drainage.

19 GREASE TRAY

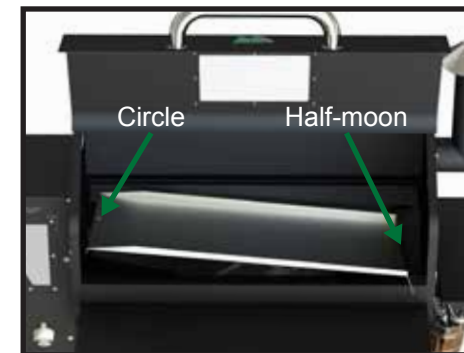

Follow grease tray cut-outs as shown.

20 GRILL GRATES



Insert grates as shown.

21 GREASE BUCKET



Hang bucket on drip spout.